



Door Security System

An ISO 9001: 2008 Certified Co.



Advance Technology Beautiful & Smart Innovations

MANUAL/CATALOGUE



INTRODUCTION



Friendly

Our approach is down-to earth and just plain friendly. We love our clients, we love seeing you succeed, and we are here to help.



Thoughtful

We take an inquisitive, methodic approach to every project to ensure that we find the best solution possible. Keeping our clients' Best interests at heart is a way of life for us.



Forthcoming

We value transparent, candid communication and contracts. Expect us to be straightforward and up front regarding all aspects of your project, from start to finish.



Responsive

Some manf. companies are nearly unreachable. we prioritize available to our clients and see good communication as a key to reliability and trustworthiness.



Robust

We love quality. we are passionate about details, from concept to launch, our products and quality projects are thoroughly tested and built to last.



Intuitive

Technology can be frustratingly complex. We aim to keep things as painless as possible. Our goal is that your experience will be simple and enjoyable.

AVAILABLE FINISHES



S.G - Silver Gold



B.P.L - Brass Polish Lacquer



B.G - Black Gold



S.S - Silver Satin



N.S - Nickle Silver



B.A - Brass Antique





Door Security System

An ISO 9001: 2008 Certified Co.



Brass

Mortice Range





Brass MORTICE HANDLES

Available Size-14",10",5" & Rose



ABP/01
350mm



ABP/01
250mm



ABP/01
125mm



ABP/01 R



ABP/02
350mm



ABP/02
250mm



ABP/02
125mm



ABP/02 R

Available Size-14",10",8",5" & Rose

Architectural
Builder's Hardware

Computerised,
Ultra, Reversible
& Regular Keys

Ultra Keys
Combination
in Millions

High Grade
AISI 304 Stainless Steel

All Types of
Finishes Available



Brass MORTICE HANDLES

Available Size-14",10",8",5" & Rose



ABP / 03
350mm



ABP / 03
250mm



ABP / 03
125mm



ABP / 03 R



ABP / 04
300mm



ABP / 04
125mm



ABP / 04 R

Available Size-12",5" & Rose



ABP / 05
250mm
200mm



Brass MORTICE HANDLES



ABH 1409
350mm



ABH 1410
350mm



ABH 1411
350mm



ABH 1429
350mm



ABH 1241
300mm



ABH 1251
300mm



ABH 1298
250mm



Brass MORTICE HANDLES



ABH 1139
275mm



ABH 1143
275mm



ABH 1149
275mm



ABH 1131
275mm

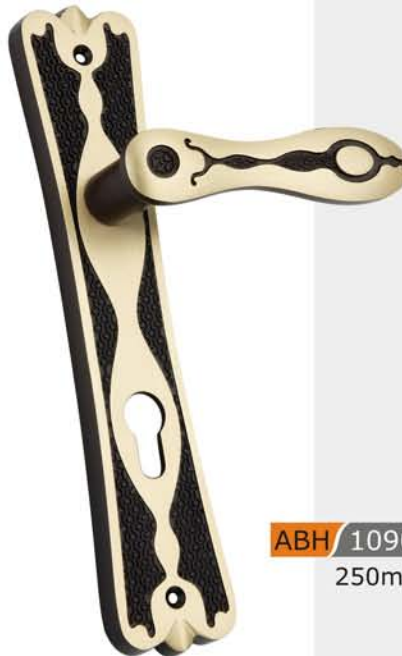

ABH 1090
250mm



ABH 1095
250mm



Brass **MORTICE HANDLES**



ABH/701
175mm



ABH/706
175mm



ABH/713
175mm



ABH/714
175mm



ABH/842
200mm



ABH/861
200mm



ABH/862
200mm





Door Security System

An ISO 9001: 2008 Certified Co.



SS

**Mortice
Range**



SETTING THE STANDARD IN SELECTING THE BEST STAINLESS STEEL PRODUCTS

High Grade, AISI 304 Grade Stainless Steel

SS MORTICE HANDLES



ASH/801
200mm



ASH/821
200mm



ASH/822
200mm



ASH/823
200mm



ASH/824
200mm



ASH/831
200mm



SETTING THE STANDARD IN SELECTING THE BEST STAINLESS STEEL PRODUCTS

High Grade, AISI 304 Grade Stainless Steel

SS MORTICE HANDLES



ASH/832
200mm



ASH/833
200mm



ASH/851
200mm
250mm



ASH/852
200mm
250mm



ASH/853
200mm
250mm



ASH/854
200mm
250mm



SETTING THE STANDARD IN SELECTING THE BEST STAINLESS STEEL PRODUCTS

High Grade, AISI 304 Grade Stainless Steel

SS ROSE HANDLES



ASR/52



ASR/53



ASR/54

SS MORTICE HANDLES



ASZH/081
200mm



ASZH/083
200mm



ASZH/082
200mm



ASZH/084
200mm



SS MORTICE HANDLES



ASH/020
250mm



ASH/020
200mm



ASH/020
125mm

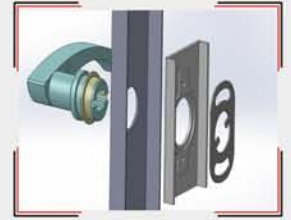

Available Size-10",8",5"
& Rose



ASH/021
250mm



ASH/021
200mm



ASH/021
125mm

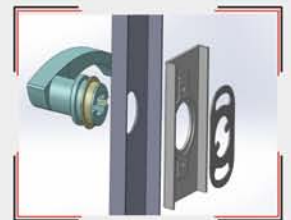

Available Size-10",8",5"
& Rose

Architectural
Builder's Hardware

Computerised,
Ultra, Reversible
& Regular Keys

Ultra Keys
Combination
in Millions

High Grade
AISI 304 Stainless Steel

All Types of
Finishes Available



SS MORTICE HANDLES



ASH/022
250mm



ASH/022
200mm

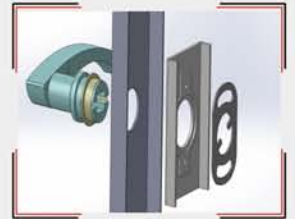

Available Size-10",8",5"
& Rose



ASH/022
125mm



ASH/P-01
250mm



ASH/P-01
200mm

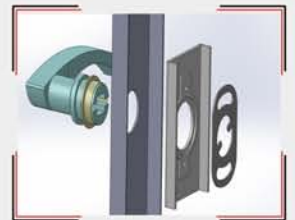

Available Size-10",8",5"
& Rose



ASH/P-01
125mm



Door Security System

An ISO 9001: 2008 Certified Co.

Iron
Mortice
Range



Iron MORTICE HANDLES



AIH/01
175mm



AIH/01
125mm



AIH/02
175mm



AIH/02
125mm



AIH/04
175mm



AIH/04
125mm



AIH/03
175mm



AIH/03
125mm



AIH/05
175mm



AIH/05
175mm



Iron MORTICE HANDLES



AIH/06
175mm



AIH/06
125mm



AIH/07
175mm



AIH/07
125mm



AIH/08
175mm



AIH/08
125mm



AIH/010
175mm



AIH/010
125mm





Iron MORTICE HANDLES



AIH / 111
200mm



AIH / 111
125mm

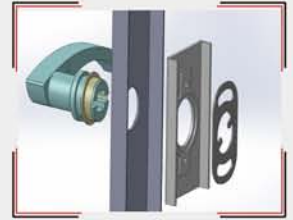

Available Size-10",8",5"
& Rose



ARH / 111



AIH / 112
200mm



AIH / 112
125mm

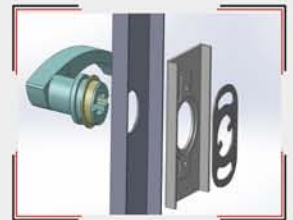

Available Size-10",8",5"
& Rose



ARH / 112



Iron MORTICE HANDLES



AIH / 112-D1
200mm



AIH / 112-D1
125mm



ARH / 112-D1

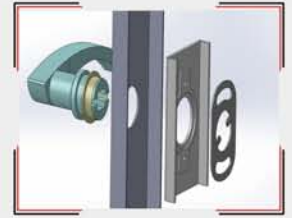

Available Size-10", 8", 5"
& Rose



AIH / 112-D2
200mm



AIH / 112-D2
125mm



ARH / 112-D2

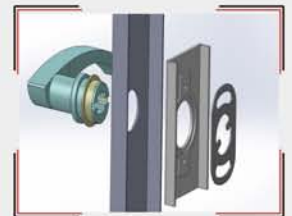

Available Size-10", 8", 5"
& Rose



Iron MORTICE HANDLES



AIH / 112-P
200mm



AIH / 112-P
125mm

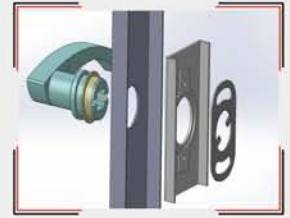

Available Size-10", 8", 5"
& Rose



ARH / 112-P



AIH / 113
200mm



AIH / 113
125mm

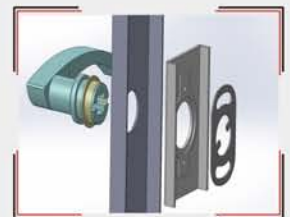

Available Size-10", 8", 5"
& Rose



ARH / 113



Iron MORTICE HANDLES



AIH / 114
200mm



AIH / 114
125mm

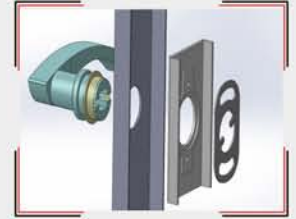

Available Size-10", 8", 5"
& Rose



ARH / 114



AIH / 116
200mm



AIH / 116
125mm

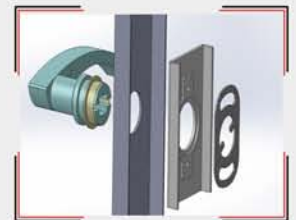

Available Size-10", 8", 5"
& Rose



ARH / 116



Iron MORTICE HANDLES



AIH / 117
200mm



AIH / 117
125mm

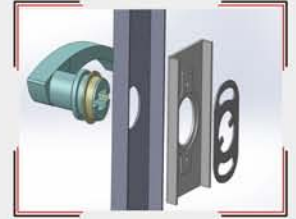

Available Size-10",8",5"
& Rose



ARH / 117



AIH / 118
200mm



AIH / 118
125mm

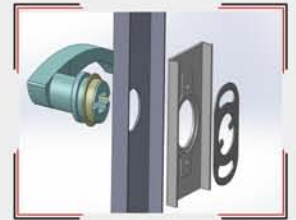

Available Size-10",8",5"
& Rose



ARH / 118



Iron MORTICE HANDLES



AIH / 119
200mm



AIH / 119
125mm

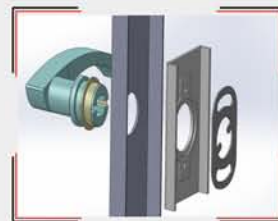

Available Size-10",8",5"
& Rose



ARH / 119



AIH / 120
200mm



AIH / 120
125mm

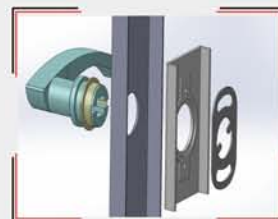

Available Size-10",8",5"
& Rose



ARH / 120



Iron MORTICE HANDLES



AIH / 121
200mm



AIH / 121
125mm

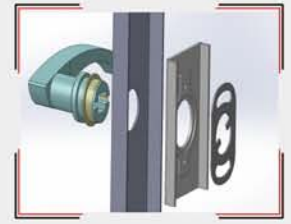

Available Size-10", 8", 5"
& Rose



ARH / 121

Iron
Mortice
Handles



Architectural
Builder's Hardware

Computerised,
Ultra, Reversible
& Regular Keys

Ultra Keys
Combination
in Millions

All Types of
Finishes Available



Door Security System

An ISO 9001: 2008 Certified Co.



Zinc

Mortice
Range



Zinc MORTICE HANDLES



AZH/01
200mm



AZH/02
200mm



AZH/03
200mm



AZH/04
200mm



AZH/05
200mm



AZH/06
200mm



Zinc MORTICE HANDLES



AZH/07
200mm



AZH/08
200mm



AZH/09
200mm



AZH/10
200mm



AZH/11
200mm



AZH/12
200mm



MORTICE CYLINDERS



Brass Range

Also Available Upto 100mm



OSK / 60mm
Premium Knob



OSK / 60mm
Normal Knob



BSK / 60mm

Zinc Range

Also Available Upto 100mm



OSK / 60mm
Premium Knob



OSK / 60mm
Normal Knob



BSK / 60mm

Coin & Half Cylinder Is Also Available



Premium Knob



Normal Knob

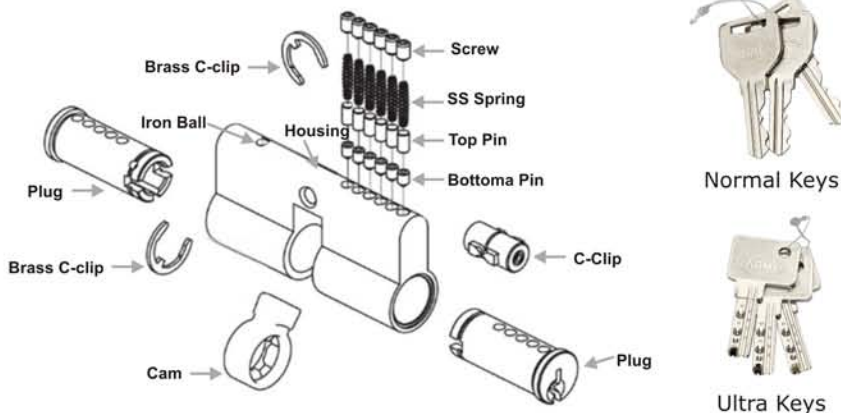

Architectural
Builder's Hardware

Computerised,
Ultra, Reversible
& Regular Keys

Ultra Keys
Combination
in Millions

High Grade
AISI 304 Stainless Steel

All Types of
Finishes Available



MORTICE LOCKS



CY/01-BSS

- Top & bottom Cover : High Grade Stainless Steel Pierced to a accept Bolt through fitting.
- Follower : Brass to Suit 8mm Spindle
- Latch Bolt : Brass, Easily reversible from outside by push & turn method
- Dead Bolt : Brass Double Action
- Fore-end & Striking Cram : Brass or Stainless Steel, Finished to match with cylinder.



CY/01

- Top & bottom Cover : Powder Coated & Pierced to a accept Bolt through fitting.
- Follower : Brass to Suit 8mm Spindle
- Latch Bolt : Brass, Easily reversible from outside by push & turn method. Finish BPL & CP.
- Dead Bolt : Brass Double Action. Finish BPL, CP & SS.
- Fore-end & Striking Cram : Brass or Stainless Steel, Finished to match with cylinder.



CY/03

- Top & bottom Cover : Powder Coated & Pierced to a accept Bolt through fitting.
- Follower : Brass to Suit 8mm Spindle
- Latch Bolt : Brass, Easily reversible from outside by push & turn method. Finish BPL & CP.
- Dead Bolt : 3 Brass Pins. Finish BPL, CP & SS
- Fore-end & Striking Cram : Brass or Stainless Steel, Finished to match with cylinder.



CY/04-BH

- Top & bottom Cover : Powder Coated & Pierced to a accept Bolt through fitting.
- Follower : Brass to Suit 8mm Spindle
- Latch Bolt : Brass, Easily reversible from outside by push & turn method. Finish BPL & CP.
- Dead Bolt : 4 Heavy Steel Bullets (303Grade)
- Fore-end & Striking Cram : Brass or Stainless Steel, Finished to match with cylinder.

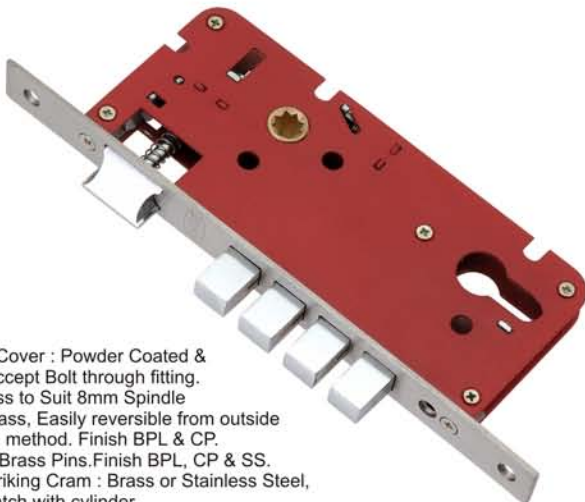

CY/04

- Top & bottom Cover : Powder Coated & Pierced to a accept Bolt through fitting.
- Follower : Brass to Suit 8mm Spindle
- Latch Bolt : Brass, Easily reversible from outside by push & turn method. Finish BPL & CP.
- Dead Bolt : 4 Brass Pins. Finish BPL, CP & SS.
- Fore-end & Striking Cram : Brass or Stainless Steel, Finished to match with cylinder.



CY/14-B

- Top & bottom Cover : Powder Coated & Pierced to a accept Bolt through fitting.
- Follower : Brass to Suit 8mm Spindle
- Latch Bolt : Brass, Easily reversible from outside by push & turn method. Finish BPL & CP.
- Dead Bolt : 4 Steel Bullets (303Grade)
- Fore-end & Striking Cram : Brass or Stainless Steel, Finished to match with cylinder.



MORTICE LOCKS



CY/01-3S

- Top & bottom Cover : High Grade Stainless Steel Pierced to a accept Bolt through fitting.
- Follower : Brass to Suit 8mm Spindle
- Latch Bolt : Brass, Easily reversible from outside by push & turn method.
- Dead Bold : Brass Double Action
- Fore-end & Striking Cram : Brass or Stainless Steel,
- Finished to match with cylinder.



CY/03-BS

- Top & bottom Cover : Powder Coated & Pierced to a accept Bolt through fitting.
- Follower : Brass to Suit 8mm Spindle
- Latch Bolt : Brass, Easily reversible from outside by push & turn method.
- Dead Bold : 3 Steel Bullets (303 Grade)
- Fore-end & Striking Cram : Brass or Stainless Steel,
- Finished to match with cylinder.



CY/03-S

- Top & bottom Cover : Powder Coated & Pierced to a accept Bolt through fitting.
- Follower : Brass to Suit 8mm Spindle
- Latch Bolt : Brass, Easily reversible from outside by push & turn method.
- Dead Bold : 3 Brass Pins.Finish BPL, CP & SS.
- Fore-end & Striking Cram : Brass or Stainless Steel, Finished to match with cylinder.



CY/03-D

- Top & bottom Cover : Powder Coated & Pierced to a accept Bolt through fitting.
- Dead Bold : Brass Double Action, BPL, CP & SS.
- Fore-end & Striking Cram : Brass or Stainless Steel,
- Finished to match with cylinder.
- Rose : Stainless Steel Brushed
- 2 Nos. with Plastic Mounting Discs.



CY/01-S

- Top & bottom Cover : Powder Coated & Pierced to a accept Bolt through fitting.
- Follower : Brass to Suit 8mm Spindle
- Latch Bolt : Brass, Easily reversible from outside by push & turn method.
- Dead Bold : Brass Double Action, BPL, CP & SS.
- Fore-end & Striking Cram : Brass or Stainless Steel,
- Finished to match with cylinder.



CY/01-D

- Top & bottom Cover : Powder Coated & Pierced to a accept Bolt through fitting.
- Dead Bold : Brass Double Action, BPL, CP & SS.
- Fore-end & Striking Cram : Brass or Stainless Steel,
- Finished to match with cylinder.
- Rose : Stainless Steel Brushed
- 2 Nos. with Plastic Mounting Discs.



MORTICE LOCKS



AML-05 HSS

- Top & bottom Cover : High Grade Stainless Steel
- Fore-end cram : Stainless Steel Cover.
- Striking cram : Stainless Steel, Bended.
- Follower : Brass
- Dead bolt : Brass, Double action
- Latch : Brass Easily reversible from outside of the case by push & turn method.
- Keys : 3 Nos. Forged Steel, Chrome Plated
- Size : 65mm



AML-03

- Top & bottom Cover : Steel, Powder Coated.
- Fore-end cram : Stainless Steel Cover.
- Striking cram : Stainless Steel, Bended.
- Follower : Brass
- Dead bolt : Brass, Double action, CP/SS.
- Latch : Brass, CP/SS, Easily reversible from outside of the case by push & turn method.
- Keys : 3 Nos. Forged Steel, Chrome Plated
- Size : 65mm



AML-05

- Top & bottom Cover : Steel, Powder Coated.
- Fore-end cram : Stainless Steel Cover.
- Striking cram : Stainless Steel, Bended.
- Follower : Brass
- Dead bolt : Brass, Double action, CP/SS.
- Latch : Brass, CP/SS, Easily reversible from outside of the case by push & turn method.
- Keys : 3 Nos. Forged Steel, Chrome Plated
- Size : 70mm



AML-01

- Top & bottom Cover : Steel, Powder Coated.
- Fore-end cram : Stainless Steel Cover.
- Striking cram : Stainless Steel, Bended.
- Follower : Zinc casted, Chrome plated to
- Dead bolt : Brass, D/A,S/A, CP/SS.
- Latch : Brass, CP/SS, Easily reversible from outside of the case by push & turn method.
- Keys : 2 Nos. Forged Steel, Chrome Plated
- Size : 65mm



ABL-03

- Steel Drawn Case - Powder Coated
- Follower : Brass
- Latch Bolt easily reversible from outside of the case.
- Pierced to accept bolt through fittings.
- Fore-end & Striking cram in stainless steel.
- Size : 70mm



ABL-02

- Steel Drawn Case - Powder Coated
- Follower : Zinc Casted, Chrome Plated
- Latch Bolt easily reversible from outside of the case.
- Pierced to accept bolt through fittings.
- Fore-end Cram Stainless Steel Cover
- Striking cram in stainless steel.
- Size : 65mm





DOOR LOCKS

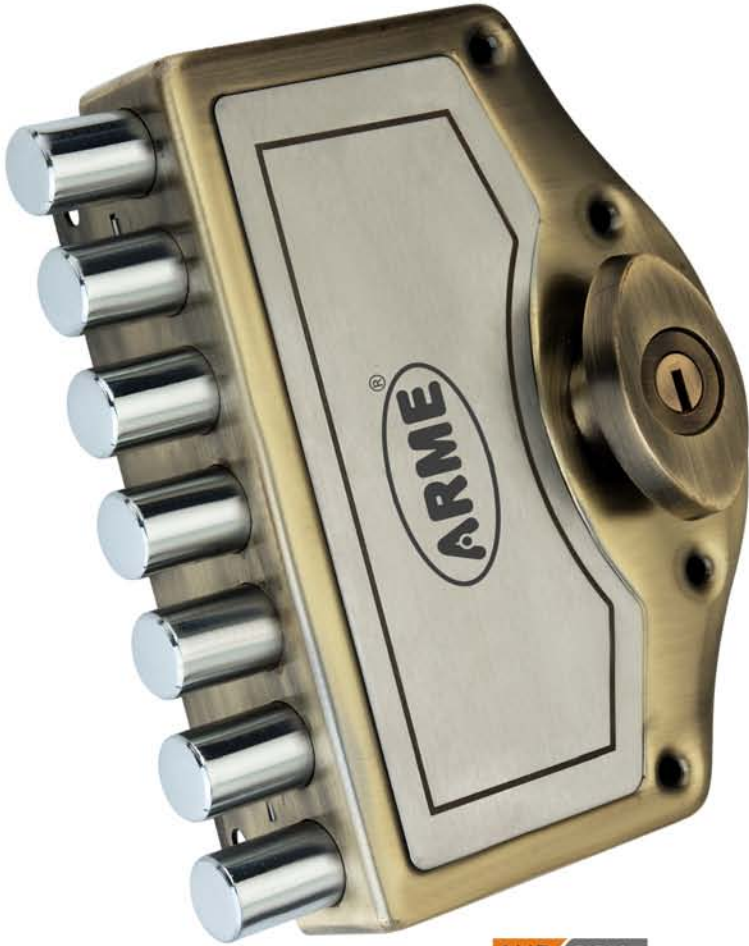

AHB/2CK
HEPTA BOLT



ATB/1CK
TRI BOLT



ATB/2C
TRI BOLT



AVB/1CK
VERTI BOLT
2CK Also Available



Key With LED



Tri Bolt Latch

Architectural
Builder's Hardware

Computerised,
Ultra, Reversible
& Regular Keys

Ultra Keys
Combination
in Millions

High Grade
AISI 304 Stainless Steel

All Types of
Finishes Available



Door Security System

An ISO 9001: 2008 Certified Co.

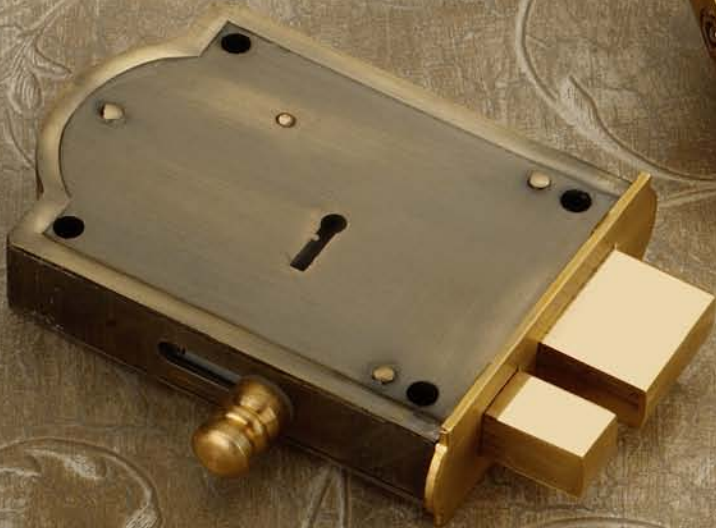

Door Locks Range



DOOR LOCKS



ADL/05 Antq.



ADL/05 Brass Latch



ADL/04 S. Latch



ADL/05 S. Latch



ADL/03 Solid



ADL/04 Solid



ADL/03 Bullet

Architectural
Builder's Hardware

Computerised,
Ultra, Reversible
& Regular Keys

Ultra Keys
Combination
in Millions

High Grade
AISI 304 Stainless Steel

All Types of
Finishes Available



DOOR LOCKS



ADL/04 Nikil
Premium Heavy



ADL/04 Nikil
Premium Slim

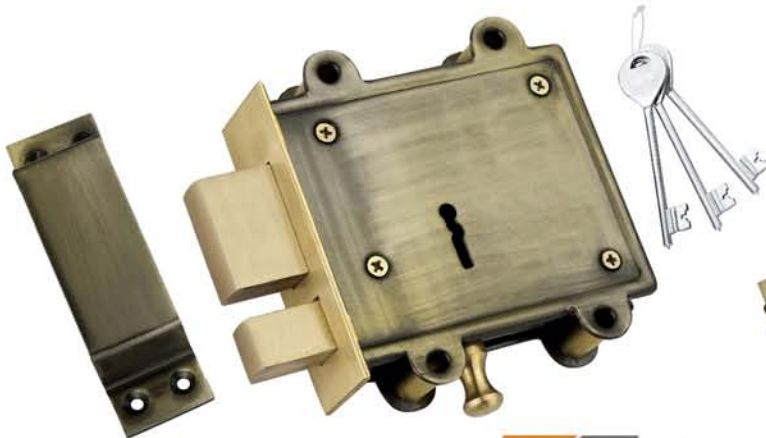

ADL/04 Antq.
Premium Heavy



ADL/04 Antq.
Premium Slim



ADL/04
B- Latch



ADL/04
Bullet

Architectural
Builder's Hardware

Computerised,
Ultra, Reversible
& Regular Keys

Ultra Keys
Combination
in Millions

High Grade
AISI 304 Stainless Steel

All Types of
Finishes Available

HEPTA DOOR BOLT



ARME

GUPTA INDUSTRIES

Aligarh-202001

E-mail:-customercare@armelocks.com

info@armelocks.com

web:- www.armelocks.com / guptaindustries.net

